



The base manual was created by MIO, and edited/revised in the US at the Magellan office in San Dimas, CA by Jay Maechtlen.



User Manual

CYCLO™ 315/505 Series

Welcome

Thank you for purchasing this Magellan Cyclo . Please read this manual carefully before using your Magellan for the first time. Keep this manual in a safe place and use as your first point of reference.

Important information for using the manual

It is important to understand the terms and typographical conventions used in this manual.

Bold — Components or items displayed on screen, including buttons, headings, field names and options.

Italics — Indicates the name of a screen.

Disclaimer

Not all models are available in all regions.

Depending on the specific model purchased, the color and look of your device and accessories may not exactly match the graphics shown in this document.

Magellan operates a policy of ongoing development. Magellan reserves the right to make changes and improvements to any of the products described in this document without prior notice. Magellan does not warrant that this document is error-free. The screenshots and other presentations shown in this manual may differ from the actual screens and presentations generated by the actual product. All such differences are minor and the actual product will deliver the described functionality as presented in this User Manual in all material respects.

Copyright

© 2014 MiTAC International Corporation. Magellan is a registered trademark of MiTAC International Corporation. All rights reserved.

All other trademarks and registrations are the property of their respective owners.

ANT+™  is a trademark of Dynastream Innovations Inc. or its subsidiaries.

112-0075-001A

Revision: R00

Contents

Welcome

| | |
|--|---|
| Important information for using the manual | 2 |
| Disclaimer..... | 2 |
| Copyright | 2 |

Contents

Knowing your device

| | |
|------------------|---|
| Main unit | 4 |
| Accessories..... | 4 |

Getting started

| | |
|--|---|
| Charging the battery..... | 5 |
| Performing the initial start-up..... | 5 |
| Connecting your device to the computer | 6 |

Installing the device

| | |
|---|---|
| Provided Mounts..... | 6 |
| Installing the Forward mount | 6 |
| Installing the Pad-Style mount..... | 7 |
| Installing the sensors on your bike | 8 |
| Putting on the heart rate monitor..... | 9 |
| Battery Replacement Information:..... | 9 |

Operating basics

| | |
|-----------------------------|----|
| Using the POWER button..... | 10 |
| Using the touch screen..... | 10 |
| Main menu..... | 11 |
| Keyboard screen | 12 |

Viewing Dashboard screens

Starting navigation

| | |
|--------------------------------|----|
| Without the wizard..... | 14 |
| Using the Navigate wizard..... | 14 |
| Navigating to Home | 15 |

| | |
|---|----|
| Finding the location by Address..... | 15 |
| Searching for a POI..... | 15 |
| Searching for a location from the map screen..... | 15 |
| Searching for a location using GPS coordinates..... | 16 |
| Navigating to a saved Favorite..... | 16 |
| Tracks..... | 16 |
| GPX Data Information:..... | 17 |
| Other navigating options..... | 17 |
| Surprise Me™ | |
| Loop..... | 19 |
| A to B (Address, POI, Favorite, or Point on map)..... | 19 |
| Workout mode | |
| Workout by Distance..... | 20 |
| Workout by Time..... | 20 |
| Workout by Calories..... | 20 |
| Workout by HR Zone..... | 21 |
| Workout by Power Zone..... | 21 |
| Indoor training mode..... | 21 |
| Viewing the History | |
| Viewing recorded data..... | 22 |
| Managing data on the device | |
| Using MagellanCyclo..... | 22 |
| Sharing your route with friends in the trip..... | 23 |
| Using WiFi (wireless local area network)..... | 23 |
| Pairing with your smartphone | |
| Receiving incoming calls..... | 25 |
| Receiving text messages..... | 25 |
| Playing music..... | 26 |
| Audible Alerts..... | 26 |
| Customizing your device | |
| Profiles..... | 27 |
| Routing..... | 27 |
| Dashboard..... | 28 |

| | |
|-------------------|----|
| Sensors..... | 29 |
| Shimano Di2..... | 29 |
| Phone..... | 29 |
| WiFi sync..... | 30 |
| Where Am I..... | 30 |
| Screen..... | 30 |
| Transfer..... | 30 |
| Maps..... | 31 |
| Alerts..... | 31 |
| Manage..... | 31 |
| Define Zones..... | 31 |
| Compass..... | 32 |
| Language..... | 32 |
| Keyboard..... | 32 |
| Date & Time..... | 33 |
| Units..... | 33 |
| Product Info..... | 33 |

For more information

| | |
|---------------------------------|----|
| Online support..... | 33 |
| Caring for your Cyclo..... | 33 |
| Troubleshooting..... | 34 |
| What is GPS?..... | 34 |
| IPX7..... | 35 |
| Safety precautions..... | 35 |
| Regulatory information..... | 36 |
| Bluetooth..... | 36 |
| WEEE..... | 37 |
| End User License Agreement..... | 37 |

Knowing your device

Main unit



- 1. Charge Indicator**
Indicates the level of internal battery charge:
Green - battery full; Orange - battery charging.
- 2. POWER button**
Turns your device on/off.
- 3. Touch screen**
 - Displays the output of your device.
 - Tap the screen with your finger to select menu commands or enter information.
- 4. Mini-USB connector**
Connects to the charger or USB cable.
- 5. Bike mount socket**
For the device mount.

Accessories

Your device comes with the following accessories. To use your device on a bike, ensure you use the specific bike mount kit that came with your device. Magellan may provide optional accessories for specific models. Please visit the [Cyclo website \(www.magellancyclo.com\)](http://www.magellancyclo.com) for information.

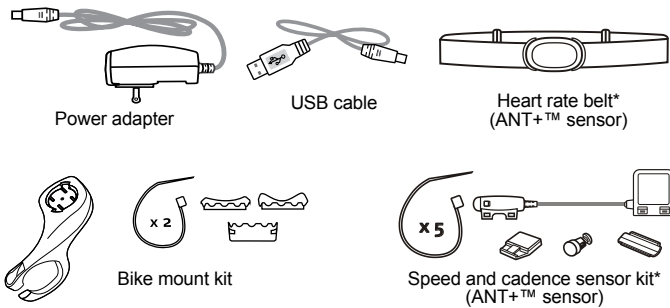

Note: Depending on the specific model purchased, the color and look of your device and accessories may not exactly match the graphics shown in this document.

* May be sold separately and used for selected models only.

Information:

This device is ANT+ certified. Visit www.thisisant.com/directory for a list of compatible products and apps.

Getting started

Charging the battery

Your device has an internal battery that may not be fully charged when you purchase it. You should charge the battery for at least 8 hours before you start using it for the very first time.

To charge the battery:

- **Using a power socket**

Plug the home charger cable into the USB connector on the back of your device and the charger into the AC outlet.

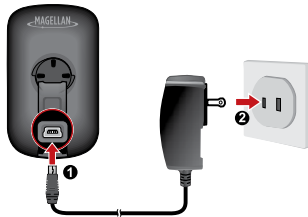

- **Via the computer**

Connect your device to the computer by using the provided USB cable. For more information, see "Connecting your device to the computer" in this section.

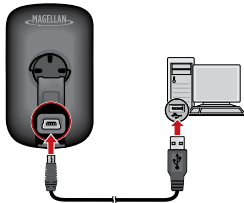

CAUTION:

For optimal performance of the lithium battery, note the following:

- Do not charge the battery where the temperature is high (e.g. in direct sunlight).
The battery will stop charging when the ambient temperature is less than -10°C (14°F) or more than 60°C (140°F).
- Recharge the battery when it is nearly discharged. When recharging, make sure that the battery is fully charged. Doing so can extend the battery life.
- If you will not use the product for a long period of time (over one month) or find the discharge/recharge time has been shortened, be sure to fully discharge the battery first before recharging it. You are also advised to fully discharge and recharge the battery once every 1~2 months.
- Failure to follow the battery usage instructions could cause damage to your device, battery and even bodily injury or property damage and will void the warranty.

Performing the initial start-up

1. Mount the device and accessories on to your bike. For more information, see the "Installing the device" section.
2. Press and hold the POWER button for 3 seconds to turn your device on.

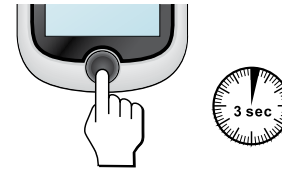

3. Follow the prompts to personalize your device, including:

- Select your preferred language.
- Set the date and time.
- Set the units format.
- Create your user profile.

Note: You can change these settings later by tapping Main menu > Settings.

- Once your device is turned on, it will search for satellite signals automatically. This may take several seconds depending on the location.

When GPS is fixed, the GPS signal icon () on the screen indicates the GPS status.

- Depending on your device model, it will also automatically scan for heart rate monitor and cadence/speed sensor and prompt to pair them with Cyclo.

See the following section for sensor installation and pairing.

You can also scan the accessories manually by tapping Main menu > Settings > Sensors.

Connecting your device to the computer

- Turn on the computer.
- Turn on your device. Connect the mini-USB end of the USB cable to the back of your device and the other end to a USB port on your computer.
- Select the desired connection type from the pop-up message window:
 - Connect to PC:** Your device will be recognized as two external mass-storage drives: Mgn_system and Mgn_data. You can use Windows File Explorer to copy/move the files from the computer to your device. A USB Connection screen appears to prevent you from using your device.
 - DO NOT delete any files that are pre-installed on the device.** Deleting the files can cause the device to crash. Magellan is not responsible for product quality caused by file deletion.
 - Charge only:** You will be able to continue using your device with the battery in charging mode via the computer.

For additional information, see *page 22 Managing data on the device.*

Installing the device

Follow the instructions in this section to mount the device and the cadence/speed sensor kit (for selected models only) on your bike. In addition, you will need to put on the heart rate monitor during your workouts.

Provided Mounts

Two styles of mounts may be provided for the device. These are the forward mount and the pad-style mount. If both are included with your kit, you may use either, or mount them on two different bikes.

Installing the Forward mount

The forward mount is sized for a 31mm bar. For a smaller bar, a shim is required. Shims are not provided with the device.

On the side of the handlebar where you'll install the forward mount:

- Remove the handgrip and brake handle

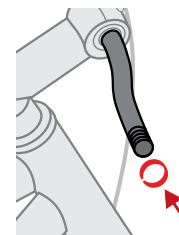
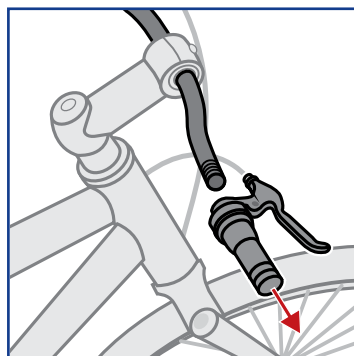

- Remove other items on the bar (such as shift lever) as needed.
- Slide the forward mount into position and make sure it fits the way you want it.

4. Using shims if needed, secure the forward mount to the handlebar.
5. Re-install removed items and adjust as needed.
6. See *page 8 Mounting the Device* to attach and remove the device from the mount.

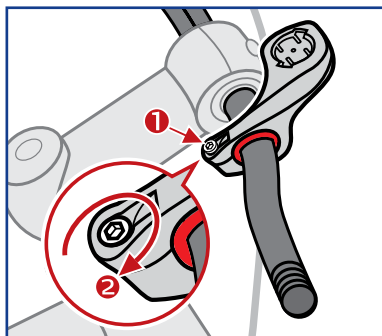
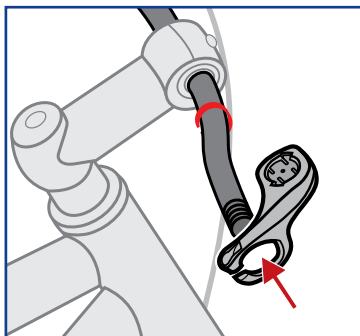

Installing the Pad-Style mount

The bike mount kit includes two types of rubber pads, allowing you to attach the bike mount to your bike securely.

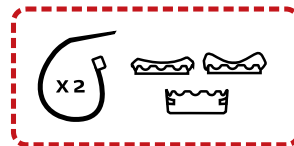

1. Select the rubber pad that best fits the handle bars on your bike and then attach it using the two plastic straps.

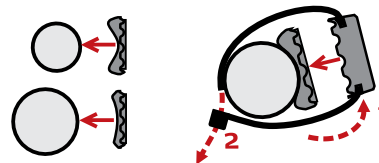

2. Align the latch on the back of the device with the slot on the bike mount, and then rotate the device clockwise to lock the device to the bike mount.

You can choose to mount the device on the handlebar (a) or on the stem (b). See the following figure for the examples of mounting the device.

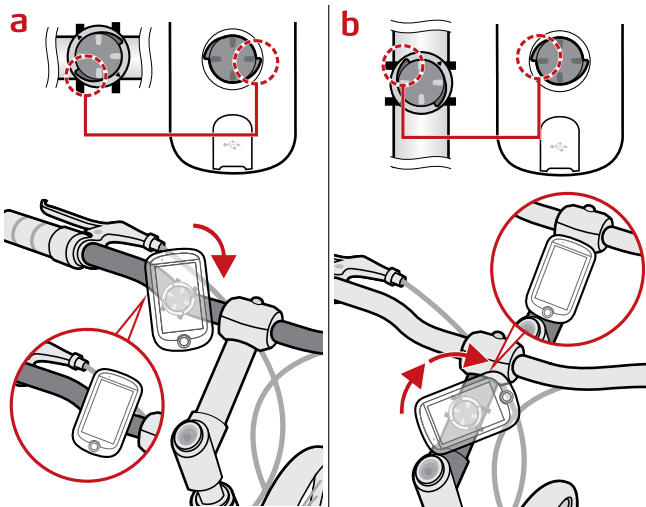

Mounting the Device

3. To remove the device from the bike mount, rotate it counterclockwise.

Installing the sensors on your bike

The cadence/speed sensor kit is used for selected models only.

1. Follow the instruction below to install the cadence/speed sensor kit on your bike.

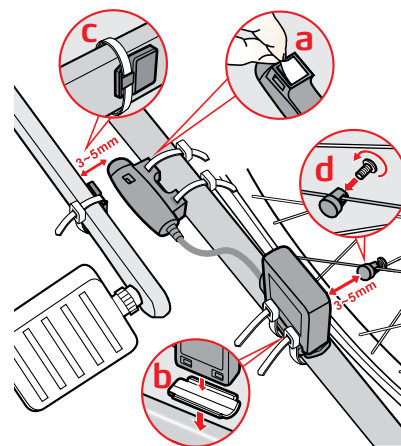

For both sensors (crank and wheel):
Set clearance between magnet and sensor
3-5 mm (1/8 - 3/16 inch)

2. Ensure that the magnets are aligned with the sensing area on the sensors.
3. When done, you can pair the sensor with your device by tapping **Main menu > Settings > Sensors > Cadence/Speed**.

Note: the sensors “sleep” when not in use to conserve battery power. They “wake up” when they receive their usual input - the Speed/Cadence sensor must “see” a magnet passing it a few times to wake up.

The sensor can only be paired within a few minutes of “waking up”, or it goes back to sleep.

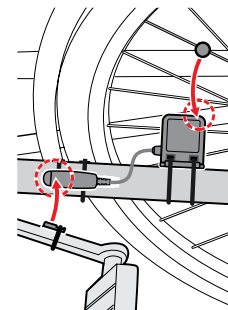

Putting on the heart rate monitor

The heart rate monitor is used for selected models only.

Note: Please note the heart rate monitor is not a medical device and its readings are not a substitute for obtaining measurements that require medical precision. It is strongly recommended to consult a doctor if you have a pacemaker or other implanted devices before using the heart rate monitor.

1. Before using the heart rate monitor, wet the contacts on the back of the chest strap.

Note: You can also use an electrolyte gel (usually available in local sports stores) to ensure good contact.

2. Adjust the elastic strap so it's snug while you are putting it on. Ensure that you can take a good deep breath after putting on the strap.

3. Follow the instructions below to wrap the strap around your back, and then secure it on the other side with the buckle.

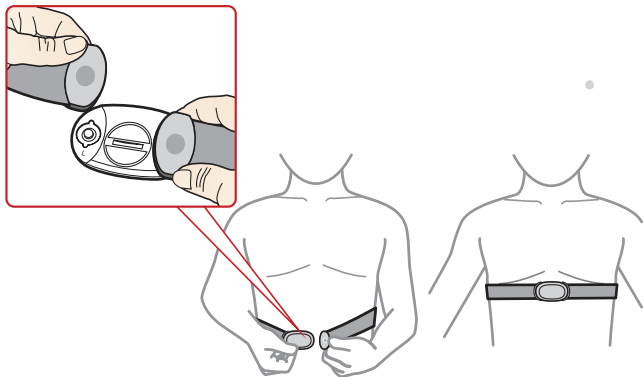

Note: Putting on the heart rate monitor is like wearing an elastic belt around your lower chest.

4. When done, you can pair the monitor with your device by tapping **Main menu > Settings > Sensors > Heart rate.**

Note: the sensors “sleep” when not in use to conserve battery power. They “wake up” when they receive their usual input - the Heart Rate Monitor’s pads must firmly touch your skin to wake up.

The sensor can only be paired within a few minutes of “waking up”, or it goes back to sleep.

Battery Replacement Information:

The cadence sensor and heart rate monitor each contain a replaceable CR2032 battery. Follow the instructions below to replace the battery:

1. Locate the battery cover on the back of the unit, and then twist the cover counterclockwise (e.g. by using a coin) to remove the cover and battery.
2. Insert the new battery into the battery chamber .
3. Making sure the rubber ring is in place, replace the cover.
4. Twist the cover clockwise (e.g. by using a coin) to close the cover.

Speed/Cadence Sensor Battery

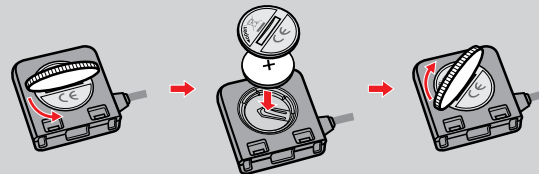

Heart Rate Monitor Battery

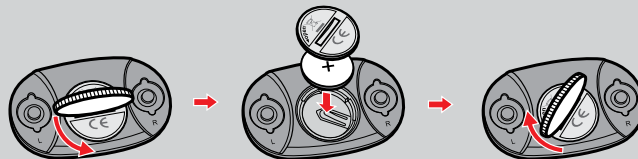

Operating basics

Using the POWER button

- **Turning on the device**

Press and hold the POWER button for 3 seconds to turn on your device.

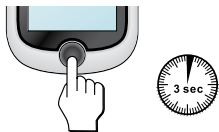

- **Turning off the device**

Press and hold the POWER button for 3 seconds to pop up the **Power Off/Cancel** screen. Choose **Power Off** to turn off the device or **Cancel** to continue operating the device.

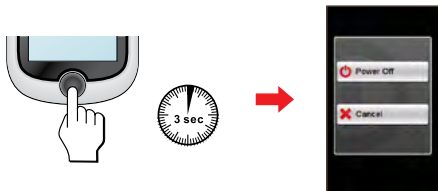

Note: Press and hold the POWER button for 5 seconds to force power off if the device doesn't respond.

Your device will automatically turn off after 10 minutes (by default) of inactivity. The **Power Off/Cancel** screen will pop up and the device will be turned off if you do not make a selection.

Note: You can change the auto power off setting by tapping **Main menu > Settings > Screen > Auto Power Off Timer**.

Using the touch screen

To operate your device, touch the screen with your finger. You can perform the following actions:

- **Tap**

Quick touch the screen once to open menus or select onscreen button/option.

- **Drag**

While navigating on the map, tap and hold on the screen without releasing your finger to move the map to the desired position.

- **Slide**

Drag your finger vertically or horizontally across the screen.

- Drag to the left/right to switch to another menu screen.
- Drag to the top/bottom to scroll up/down a list.

Note: Not all slide gestures are applicable to all screens.

Unlocking the screen

Your device will automatically lock the screen after 5 minutes (by default) of inactivity. When the screen is locked, press the POWER button briefly to unlock the screen.

Note: You can change the screen lock setting by tapping **Main menu > Settings > Screen > Screen Lock Timer**.



- **Navigating through the screens**

While the device is turned on and you are navigating through the menu screens, press the POWER button briefly to return to the previous screen.

Main menu

The Main menu is your starting place for various tasks, providing quick access to applications and settings. Tap a button to start a task or open another menu.



| Icon | Description |
|------|---|
| | The Dashboard displays the view of functions, including the map/navigation screen and the workout screen (when a workout has been selected). |
| | Start to plan your route by selecting the locations, such as home, address, tracks, POI, coordinate, favorite, etc. |
| | Your trip/training can be saved in the history records. When your ride is finished, you can check the history data such as date/time, distance, speed, altitude, etc. |
| | Based on distance or time, the device will plan 3 routes for you to choose from. |
| | You can set workouts by entering your goals, such as by distance, by time, or by calories. |
| | There are various customization options available to enhance your cycling experience. You can customise the system settings, user profiles and more. |
| | Depending on your model, when a phone is connected, you may control the music playback of your smartphone from your Cyclo device. |







| Icon | Description |
|------|---|
| | Depending on your model, when a phone is connected, you will be notified of missed calls and new text messages of your smartphone from your Cyclo device. |

The System icons

Various System icons on the title bar at the top of the screen provide the status information of your device. Depending on your settings, the icons may be different to provide various information of your device. Please note that these icons will not be always displayed during your trip/training.



| NO. | Icon | Description |
|-----|-------------------|--|
| 1 | Time display | Displays the current time. The device will automatically set the correct time based on the current GPS fixes. |
| 2 | User profile | : Bike (city bike/mountain bike/race bike) navigation mode enabled. : Running navigation mode enabled. : Indoor training mode* enabled (navigating function of the device will be disabled). |
| 3 | Heart rate* | Availability of these features (3~6) vary according to model. |
| 4 | Cadence/Speed* | If a feature is available, its icon will display when its sensor is enabled in <i>Settings > Sensors</i> . |
| 5 | Power sensor*/ ** | : The icon is not displayed unless it is enabled in the Sensors setting. |
| 6 | Di2 sensor*/ ** | / / : The icon is greyed out when enabled, but not paired with the device. / : The icon is white when the connection is made, or blinking when the pairing is in progress. |

| NO. | Icon | Description |
|-----|-------------------|--|
| 7 | Bluetooth status* | <p>When the Bluetooth function is enabled:</p> <p>: No phone is connected. The icon flashes when a connection is being made.</p> <p>: A phone is connected.</p> <p>: A call is in progress.</p> <p>: There are missed calls or new text messages on the connected phone.</p> |
| 8 | Recording status | <p>: The device is recording your trip/training.</p> <p>: Recording has been paused.</p> |
| 9 | GPS signal | <p>The GPS signal icon indicates the GPS status.</p> <p>A bar shows the strength of the GPS signal being received; the more bars the stronger the signal.</p> <p>Replaced with Trainer icon when Indoor profile with trainer is active.**</p> |
| 10 | Battery status | The Battery icon indicates the remaining battery power. |

* For selected models only.

** (selected models only),

The icons for each sensor or function are only displayed when the sensor or function is enabled in the currently selected profile.

Keyboard screen

The *Keyboard* screen will display when you are required to enter text, such as when searching for a street name. Search results will be listed in matching order, with the closest matches appearing on the screen. The *Keyboard* screen can display with various layouts depending on the information you need to enter.

Example: entering the street name while searching for an address

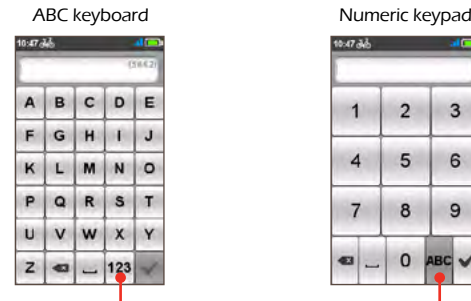



Tap to switch between the ABC keyboard and Numeric keypad.

Entering characters/numbers

- Tap the keys to enter letters or numbers.

The keyboard features the “Predictive text” technology that allows addresses to be searched easily and quickly. As you enter a letter of an address, your device will compare all possible combinations against the maps.

- Tap  to delete the character.
- When done, tap .

Changing the keyboard layout

The device also supports Russian, Bulgarian, and Greek keyboards. You can enable/disable those keyboards from **Main menu > Settings > Keyboard**. The enabled keyboards are available in addition to the English and numeric keyboards.

The keyboard selection keys will then include ABC, 123, and the additional keyboard(s) enabled.

Viewing Dashboard screens

Note: The screenshots and other presentations shown in the following sections may differ from the actual screens and presentations generated by the actual product.

The Dashboard provides the extended screens that can be used to assist you in your travels, trainings, and workouts. The layout of the dashboard screens can be customized to display the information (e.g. speed, distance, time, calories, etc.) you want to know.

Depending on your device model, certain information may not be available on the Dashboard screens. To learn how to customise the Dashboard screens, see [page 28 Dashboard](#).

- To access the Dashboard, tap  from the *Main menu* screen.
- The Dashboard function is made of screens placed next to each other: information 1 & 2, elevation, navigation/map, and workout (when started) screens.

Slide the screen to the left or right using your finger to change between the Dashboard screens.



- When the navigation/workout is in progress, you can record the data by tapping .

Note: When you are recording the route, the recorded track will be displayed as red on the map.

During recording, you can stop/pause it by tapping  and then selecting the **Stop/Pause** option when prompted; otherwise, select **Cancel** to continue recording.

- On the *Elevation* screen, the device will analyze the route and display it as the elevation plot. Use the buttons upon the plot to zoom in/out and scroll through the plot.

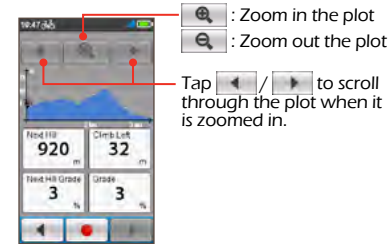

Elevation screen

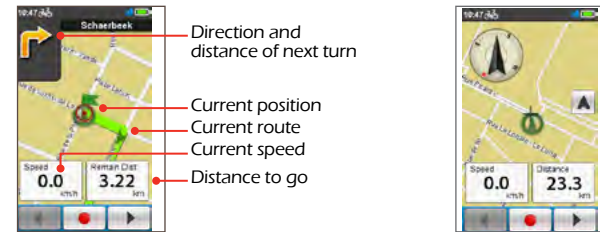

- From the *Navigation* screen, you will be directed to your destination by visual instructions. The *Map* screen is displayed when navigation has stopped. The Map screen's compass can be enabled/disabled in Settings.





Navigation screen

Map screen

Note: Tap on the *Navigation/Map* screen briefly to display the onscreen buttons.

- Tap  to zoom in/out the map.
- You can navigate the map anywhere by dragging and then moving the map. While navigating the map, tap  to display your current position on the center of the map.

Tap anywhere on the *Navigation* screen to display more buttons.

- Tap  to stop navigation.
- Tap  to avoid a certain distance of route ahead.

Starting navigation

Without the wizard

If you just go for a run or ride without setting a destination, the device will ask you if you want to record your ride. See [page 13 Viewing Dashboard screens](#) for more about recording. The Dashboard screens will display information from any connected sensors and a map centered on your location.

Using the Navigate wizard

Your device is equipped with maps that provide street-level detail for navigation, including locations of POIs (Point of Interest) such as bike stores, restaurants, emergency facilities, and more. The Navigate wizard allows you to search the location easily.





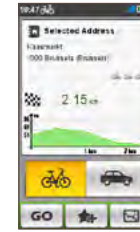

By using the Navigate wizard, there are several ways to select your destination. For example, you can tap the **Address** button to find the location by searching for an address.

1. To access the Navigate wizard, tap  from the *Main menu* screen.
2. Slide the screen to the left or right using your finger to scroll through the Navigate wizard screens and select the desired navigation function.
3. When searching is complete, the *Searching Result* screen displays the information of the route (e.g. the total distance, elevation plot, and more).



Searching Result screen

4. From the *Searching Result* screen, you can do one of the following:

- Tap **GO** to start navigating.
- Tap  and then tap **Yes** when prompted. This adds the location to **Favorite**.
- Tap  to display the route to the destination.
- Tap  /  to zoom in/out the elevation plot. Tap the Left/Right button to scroll through the plot when it is zoomed in.
- Judge the difficulty level of the route by the  icon:

   : easy

   : difficult

   : moderate

   : very difficult

- To use the **Car** navigation mode, tap (). The route will be calculated for car navigation instead of bike.
- You can tap the bike icon to re-select bike navigation.

Note: The **Car** navigation mode will only change the route by using roads appropriate for a car (e.g. the motorways or highways); it will not provide additional information for driving such as traffic status and speed limits.

Navigating to Home

Setting up your Home location

If you have not set an address as Home, the first time you try to navigate to Home you will be prompted to search for an address using the Home setup wizard.

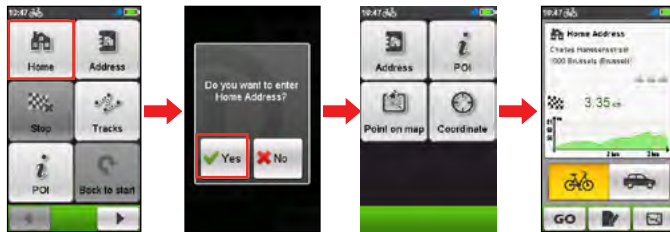

Once your home location has been set on the device, simply tap **GO** on the screen and you will be directed to Home quickly.

Editing the Home location

1. On the *Home Address* screen, tap .
2. You can change the home location by searching for an address, POI, a location on map or a GPS coordinate.
3. When done, tap **GO** to return to the *Home Address* screen.

Finding the location by Address

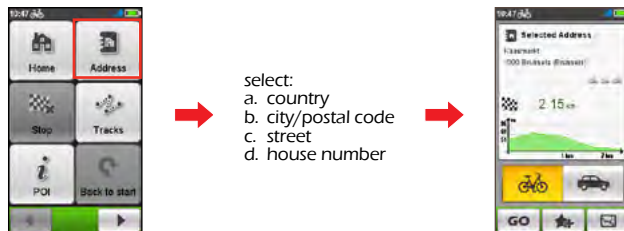

Searching for a POI

POI (Point of Interest) is a named site, feature, landmark or public venue which can be selected as a destination. POIs are grouped by category, such as bike stores, restaurants, shopping centers, and more.

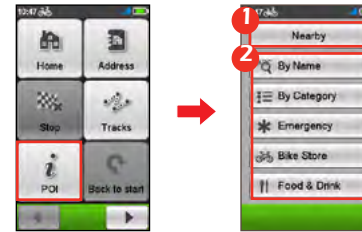

1. Tap the **Nearby** button and then select **Nearby** or **City**:
 - **Nearby**: Search for the POIs around your current position.
 - **City**: Search for the POIs in the selected city.
2. Find a POI by:
 - keyword
 - category
 - emergency/bike store/food and drink

Note: The POI(s) that you have searched previously will be displayed when you tap  from the *Navigate* screen. Simply tap the listed POI or tap **New** to find a different POI.

Searching for a location from the map screen

You can set the destination simply by pointing to it on the *map* screen.

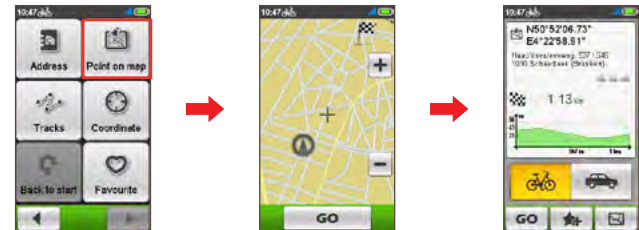

Searching for a location using GPS coordinates

You can manually input the coordinates of your target destination. Tap the **Latitude** and **Longitude** fields to enter the coordinates of the location.



Note:

- Tap the **Coordinate format** option to change the input method for the Latitude/Longitude coordinate.
- Tap **N/S** to change between North and South; tap **E/W** to change between East and West.

Navigating to a saved Favorite

Favorite has all your saved locations.

- Tap **Favorite** on the *Navigate* screen and the device will display a list of your previously saved destinations.
- Slide the screen up and down using your finger to display more entries (if available) in the list.



Note: Tap the **Sort by** button at the bottom of the screen to change the sorting order of the entries: : by time; / : by name

Tracks

Tracks are the recorded routes that give the best experience for cycling provided by other users and official institutes. If there is no track downloaded, you can download tracks from MagellanCyclo at: <http://MagellanCyclo.com>

- Tap **Tracks** on the *Navigate* screen and then you can navigate and choose from individual tracks downloaded to your device.
- Slide the screen to the left or right using your finger to display more information of the track. Tap **GO** to start navigating.



Note: Tap the **Sort by** button at the bottom of the screen to change the sorting order of the entries: : by distance; / : by name; : distance from the current location.

GPX Data Information:

GPX (GPS eXchange Format) is a XML data format that allows you to transfer GPS data (including waypoints, routes, and tracks) between your device and the computer.

When you record your travels, they are stored in GPX format.

You can retrieve the recordings from your device to the computer and then share them on the website.

If you have downloaded a gpx file from a third party website, you can install this file to your device.

To transfer gpx files between your device and the computer:

1. Ensure the track you have downloaded from the website is saved as a gpx file on the computer.
2. Turn on your device and then connect it to the computer. When prompted, select the **Connect to PC** option. Once connected, you can find two external mass-storage drives on the computer: **Mgn_system** and **Mgn_data**.

In the **Mgn_data** drive, each profile will have its own directory under **Dodge > Tracks**

3. Do one of the following:
 - To install the track to your device, copy/paste the gpx file to **Mgn_data > Dodge > Tracks**. (Don't put it in any of the profile folders.)
 - To retrieve recordings from your device, find the gpx file in **Mgn_data > Dodge > Tracks>Profile(user folder)**. Move or Copy/Paste as desired.

Example: The default profile's folder is
\\Dodge\\Tracks\\Profile1_Default_City bike

For more information about uploading/downloading tracks, visit:
<http://magellancyclo.com>

Other navigating options





Going back to start

Note: This feature is only available when the recording is in progress.

The **Back to start** function enables the device to navigate you back to the starting point after you have reached the destination or completed your ride.



In the Navigation mode field, you can:

- Select the **Bike** navigation mode () or **Car** navigation mode () to plan your route.
- Select the **Nearby** mode () to navigate to the nearest point of your track, or **Back-to-Start** mode () to navigate to the starting point of your track.

Adding a waypoint to your trip

One waypoint is allowed for your trip. Use the Navigate wizard to select a location as the waypoint (or as the new destination).



Stopping navigation

To stop navigation for your ride, tap  on the *Navigate* screen.

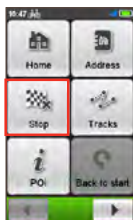



Surprise Me™

The device features the Surprise Me™ function that will offer up to three exciting routes around your location. If you've already taken a route from the same location, the device will try to propose different routes, based on the possible and available roads around your current location.

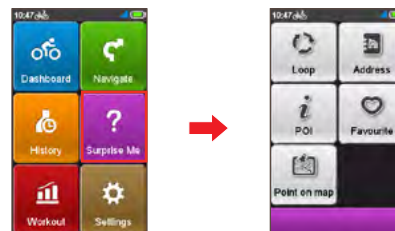
Tap  from the *Main menu* screen and then you can plan the routes randomly by selecting the following five functions: **Loop**, **Address**, **POI**, **Favorite**, and **Point on map**.



When you choose any of the Surprise Me functions to plan the routes, you can:

- Generate the route by **Distance** mode () or **Time** mode ().
- Assign the desired amount of distance/time to ride in the **Distance/Time** field.

While generating the routes using **Time** mode, you can set the estimated average speed of your trip in the **Average Speed** field. The device will calculate the estimated distance of it.

- On the *Searching Result* screen, select one route (by color buttons) and then tap **GO** to start navigating.

To view the general information of the generated routes, tap .

Loop

The device will generate up to three routes from your current location such that the start/end point will be the same as your current location.



POI



A to B (Address, POI, Favorite, or Point on map)

The device will generate up to three routes from your current location to the following destination type: **Address, POI, Favorite, or Point on map.**

Choose one of the above functions and then complete the search through the Navigate wizard.

Favorite



Point on map

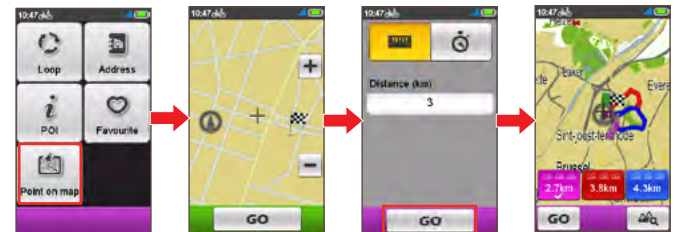

Address



Workout mode

Cycling is a good aerobic fitness exercise that helps you to burn calories, lose weight and increase your overall fitness. *Workout mode* allows you to set workouts by entering your goals (**Distance**, **Time**, **Calories**) or conditions (**HR Zone**, **Power Zone**).



When you start a workout, you can monitor the workout status through the Dashboard screens. The device will notify you when you've reached your target.

Workout by Distance

Workout by Distance is the perfect tool if you want to set how long the workout session should be exactly.

1. Tap  from the *Main menu* screen and then select the **Distance** option.
2. Complete the following:
 - In the **Distance** field, set the desired distance to go.
 - In the **Speed** field, set the estimated average speed of your trip to calculate the estimated workout time.The estimated workout session time will be calculated and shown on the screen.
- Enable or disable **Surprise Me**.

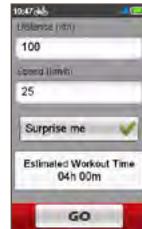

Note: For more information about Surprise Me, see the "Surprise Me" section.

3. Tap **GO** to start your workout. To stop, tap **Stop** from the *Workout* screen.

Workout by Time

Workout by Time is the perfect tool if you want to set how much time you would like to spend on the workout.

1. Tap  from the *Main menu* screen and then select the **Time** option.
2. Complete the following:

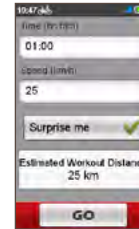

- In the **Time** field, set the desired time to go.
 - In the **Speed** field, set the estimated average speed of your trip to calculate the estimated distance of it.
- The estimated time of workout session will be calculated and shown on the screen.

- Enable or disable **Surprise Me**.

Note: For more information about Surprise Me, see the "Surprise Me" section.

3. Tap **GO** to start your workout. To stop, tap **Stop** from the *Workout* screen.

Workout by Calories



Workout by Calories allows you to set the amount of calories you want to burn during the workout.

1. Tap  from the *Main menu* screen and then select the **Calories** option.
2. In the **Calories** field, set the desired amount of calories to burn in the workout.
3. Tap **GO** to start your workout. To stop, tap **Stop** from the *Workout* screen.



Workout by HR Zone

Workout by HR Zone is available for selected models only. Select a profile with paired heart rate monitor before you start this workout.

1. Tap  from the *Main menu* screen and then select the **HR Zone** option.
2. Complete the following:
 - In the **Zone** field, select the proper heart rate range for the workout. The default setting is **Zone 2** (121 - 138 BPM).
 - Select **Time mode** () or **Distance mode** (). The route will be generated according to your selection.
 - Enable or disable **Surprise Me**.





Note: For more information about Surprise Me, see the “Surprise Me” section.

3. Tap **GO** to start your workout. To stop, tap **Stop** from the *Workout* screen.

Workout by Power Zone

Workout by Power Zone is available for selected models only. Connect the power meter (not provided) to the device before you start this workout.

1. Tap  from the *Main menu* screen and then select the **Power Zone** option.
2. Complete the following:
 - In the **Zone** field, select the desired power range for the workout. (Default setting is **Zone 2** (166 - 225 W)).
 - Select **Time mode** () or **Distance mode** (). The route will be generated accordingly.
 - Enable or disable **Surprise Me**.

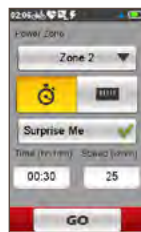

Note: For more information about Surprise Me, see the “Surprise Me” section.



3. Tap **GO** to start your workout. To stop, tap **Stop** from the *Workout* screen.

Indoor training mode

Indoor training mode is available for selected models only. Configure a profile as “Indoor” and pair the appropriate sensors before you start indoor training.

1. Create the Indoor profile from **Main menu > Settings > Profiles > Create new profile**.



2. When done, tap .
3. The  icon will appear on the title bar indicating the Indoor training mode has been enabled.
4. When an Indoor profile is selected, you can go to Settings>Sensors and pair your compatible indoor trainer.

Note: Once you enable the Indoor training mode, the GPS functions of the device are disabled, and the routing/navigating features (including **Navigate** and **Surprise Me**) are unavailable.

Viewing the History

Your device will automatically save the history as the timer starts. Information in History includes date, time, distance, average speed, cadence*, heart rate*, altitude, and more.

* For selected models only.



- To view the history data, tap  from the *Main menu* screen. A list of recorded events is shown. To view details of an entry, tap it.
- Slide the screen to the left or right using your finger to view details of the trip (or training).
- Tap **GO** to use the selected recording as a route and start navigating.

Viewing recorded data

On the *History* screen, tap the **Summary** button to select the data to view. You can select a Profile to see only the activities recorded under that profile, All Recordings to view the sum of all recorded activities, or Odometer to view the sum of all device activities (recorded or not).

When you select a profile (or All Recordings, or Odometer), you can view statistics about the recorded data* over various time periods for that profile.

Buttons are provided to select time periods (day, week, etc.) or total.

Note that only profiles with recordings will be listed for selection.

* The displayed items include: **Total Distance**, **Total Calories**, **Total Ascent**, **Average Heart Rate**, **Average Active Speed**, and **Active Time**. However, depending on your Cyclo model, certain items may not be available.

Note: The **Odometer** displays all the training data existing on the device from first use, whether the recording function was used or not.

Managing data on the device

Using MagellanCyclo

Your device comes with a desktop PC utility, MagellanCyclo, which allows you to register your device, update software and maps, share experiences, and more.

Note: Make sure you have an active Internet connection for this feature.

1. Turn on the computer.
2. Turn on your device and then connect it to the computer. When prompted, select the **Connect to PC** option.

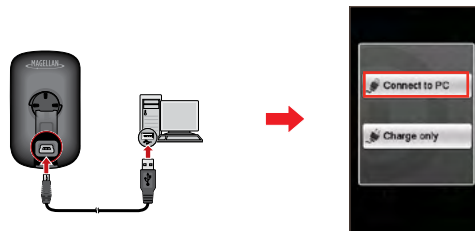

3. Find the setup file "MagellanCyclo_Setup.exe" under Mgn_system.
4. Double-click the setup file and then follow the prompts to install the desktop tool.
5. After installation, the **Magellan Cyclo** icon () will appear in the Windows system tray.
6. To update software, back up or restore your Cyclo device, right-click on the Magellan Cyclo icon and then select the desired option from the pop-up menu.

To upload or download tracks, go to MagellanCyclo website (<http://MagellanCyclo.com>) and create your MagellanCyclo account. By signing in your account, you can upload the saved tracks on your device to your MagellanCyclo account and download the available tracks on MagellanCyclo to your device.

Caution: Do not disconnect your device from the computer while transferring data.

Sharing your experience on the Internet

By using MagellanCyclo, you can easily share your experiences with other cyclists around the world through the Internet when your device is connected to the computer. For more information, visit: <http://MagellanCyclo.com/>

Sharing your route with friends in the trip

Note: For selected models only.

Your device features ANT-FS (ANT File Share) technology for exchanging data records (between the Cyclo devices within RF range), bypassing the need for cables.

To transfer your route:

1. Plan your route on the device.
2. You can go to **Main menu > Settings > Transfer** and directly tap **Send**.

Or you can enable the Shake & Share function first. To send a route to a friend, simply shake your device up and down, and then select **Send** on the pop-up message window.

3. The friend must activate Receive through **Main menu > Settings > Transfer** or **Shake & Share** (if enabled on that device).

If you are navigating, you will be prompted to stop navigating before receiving a route, (Must cancel existing route before accepting a new route.)

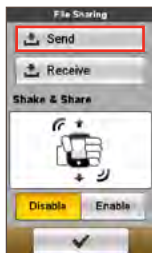

Note: The Shake & Share function of the device is disabled by default

Using WiFi (wireless local area network)

Note: This feature is only available on model 505.

You can synchronize data (e.g. upload recordings and download saved tracks) with MagellanCyclo by accessing the Internet through WiFi. WiFi allows your device to connect to the Internet through a wireless connection. To use WiFi on your device, you need access to a wireless access point.

1. Enable the WiFi function from **Main menu > Settings > WiFi Sync**.

Note: The WiFi function of the device is disabled by default.

2. The device will automatically scan for available wireless networks. The network names and security settings (public network or secured with WEP/WPA-PSK/WPA2-PSK) of the detected wireless networks will be displayed on the *WiFi settings* screen.

Note: At this time, CYCLO can't connect to wireless networks that use MAC filtering.



3. From the available networks list, tap a wireless network to connect.

- If you select a public network, tap  directly to start connecting.



- If you select a network that is secured with WEP/WPA-PSK/WPA2-PSK, enter the password and then tap .



Note:

- On the *WiFi settings* screen, tap **Refresh** to search the networks again.
- You can add a network manually by tapping **Add Network** on the *WiFi settings* screen. Enter the network name and complete the security setting, and then tap  to connect to the network.

4. When your device is connected to a wireless network, it starts to synchronize data with MagellanCyclo automatically.

Please note that you need to register your device on MagellanCyclo.com before using WiFi to synchronize data.

Note: You may see the landing page shown on the browser during connecting. Follow the onscreen instruction to login and synchronize data.

5. When done, the sync result will be displayed in the message window.

Tap **OK** to return to the *WiFi settings* screen. The WiFi connection will be disconnected automatically.

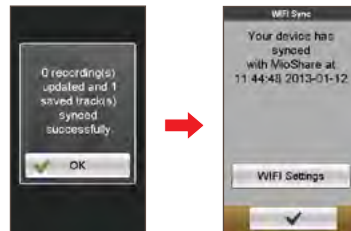

6. The next time you enable the WiFi function, it will connect to a previously accessed network automatically. You will not be prompted to enter the password (if needed) again unless you (i) tap on the network and then tap **Forget this Network**; or (ii) reset the device to its factory default settings.

Pairing with your smartphone

Note: This feature is not available on all models.

Depending on your model, your Cyclo device can be connected with iPhone or Android phones.

Note: The compatible phone types include: iPhone 4 or above, and certain Android phones equipped with Bluetooth LE. Note that not all Android phones will necessarily be equipped with Bluetooth LE, even if they have a compatible software version.

For compatibility information see www.magellangps.com/support.

Note: For Android phone users, the CycloSmart application is required for your Cyclo device to perform music control and SMS messaging with your Android phone. The application is available on Google Play.

See <https://play.google.com/store/apps/details?id=com.ivt.cyclosmart>

1. Enable the Bluetooth function on your Cyclo device from **Main menu > Settings > Phone** and tap **Pair with New Phone**.



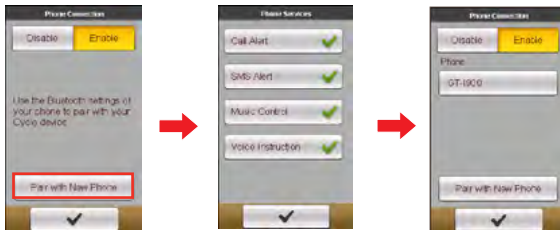

2. You can do one of the following on your smartphone for your Cyclo device to communicate with your phone.

- For iPhone, turn on the Bluetooth function in the iPhone settings and select the Cyclo device from a list of Bluetooth devices.
- For Android phones, open CycloSmart and tap **Start Pairing**.



Receiving incoming calls

By default, you will be notified with a notification and a sound when there is an incoming call. The caller's information will display on the screen if it is saved in your phonebook.

- Tap **Answer** to receive or **Ignore** to reject the call. (If you are wearing a Bluetooth headset or earpiece.)
- To adjust the volume, tap  and  (for Android phones only).
- To return to the previous screen, tap  to minimize the screen.
- To end the call, tap .

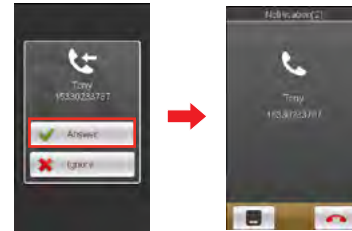

Receiving text messages

Note: For iPhone users, you need to turn on the "Show notifications" in the Bluetooth Settings in order to receive the text messages on your Cyclo device.

By default, you will be notified with a notification and a sound when there is a text message. The sender's name will display on the screen if it is saved in your phonebook.

- To view the message, tap **View Details**. To call the message sender, tap .

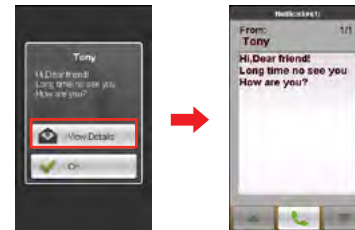

- To return to the previous screen, tap **OK**.

Playing music

When a connection is made, tap  on the *Main Menu* to open the music application.

Depending on your smartphone, tap a song and then  to open the playback screen.

Use the on-screen icons to control the playback, switch songs or adjust the volume (for Android phones only).



Audible Alerts

By pairing your Cyclo device with an Android phone and a Bluetooth headphone, you can receive audio guidances and beep alert from your Bluetooth headphone during navigation.





Note: This feature is only available for Android phones.

Customizing your device

Note: Depending on your Cyclo model, certain setting options may not be available.

There are various customization options available to enhance your navigation and cycling experience. With the Settings menu, you will be able to customise your device such as the system settings, sensor settings, user profiles, map settings, and more.



- To access the Settings menu, tap  from the *Main menu* screen.
- Tap  /  or slide the screen to the left or right using your finger to scroll through the Settings menu screens.
- While changing the settings, the check mark () next to the option button indicates the setting status.
Example: Auto Zoom : on/enabled
 Auto Zoom : off/disabled
- When the settings have been changed, tap  at the bottom of the screen to complete and return to the previous screen.

Profiles

Profiles let you configure the device for multiple types of bikes and trainers, each with their own sensors. Each profile contains information about the user, the type of bike or equipment, the sensors used, and so forth.



As an example, you might have two or more bikes, each having its own profile. You might also have a running profile. Each of the bikes would probably have its own speed/cadence sensor. However, any of those profiles that use a heart rate sensor would probably share the same sensor.

Creating a new profile

From **Main menu > Settings > Profiles** you can create and edit profiles.

The *Profile entry* screen displays the existing profile(s).



- You can set up to 6 profiles on the device.

- Tap **Create new profile**, select profile Type*
- Enter your personal data (including Name, Birth date, Weight, Gender).
- You can tap  to enter the profile, or  to fill additional information such as wheel profile and sensors used.

* You can select the profile Type as **City bike**, **Mountain bike**, **Race bike**, **Running**, or **Indoor**.

Note: The system will create different routes depending on your selected profile type (not including Indoor). For example, Mountain bike will use unpaved routes which will be avoided by using Race bike.

Editing an existing profile

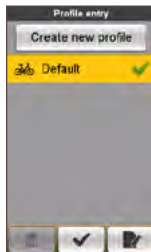

- Select an existing profile entry and then do one of the following:
 - Tap  to edit the profile.
 - Tap  to delete the profile.

Note: The profile Type **can not** be edited after creating and saving the profile. All other profile information is editable.



Routing

This setting allows you to set the routing preference by selecting **Prefer**, **Allow**, or **Try to avoid** in each route option.

- Tap  /  to select the desired routing type: **City bike**, **Race bike**, **Mountain bike**, **Car**, or **Running**.
- The available options vary according to the selected routing type:

Note: These settings can make a big difference in how a trip is routed.

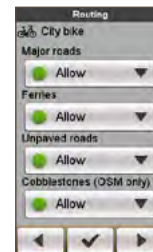

Routing types and options.



| Routing type \ Options | City bike | Race bike | Mountain bike | Car | Running |
|------------------------|-----------|-----------|---------------|-----|---------|
| Major roads | ✓ | ✓ | ✓ | | ✓ |
| Cycle routes | ✓ | ✓ | ✓ | | |
| Unpaved roads | ✓ | | ✓ | ✓ | ✓ |
| Cobblestone* | ✓ | ✓ | ✓ | | ✓ |
| Highway | | | | ✓ | |
| Ferries | | | | ✓ | |
| Walking routes | | | | | ✓ |

* For OSM only.

Dashboard

In the *Dashboard Layout Change* screen, you can change the layout of the following screens:

- Information screens (Info 1, Info 2)
- Elevation screen
- Navigation
- Map screen
- Workout screen
- History screen
- Trainer screen

Note: You can enable or disable the Info 2 and Elevation screens, Tap the  /  marks to change.

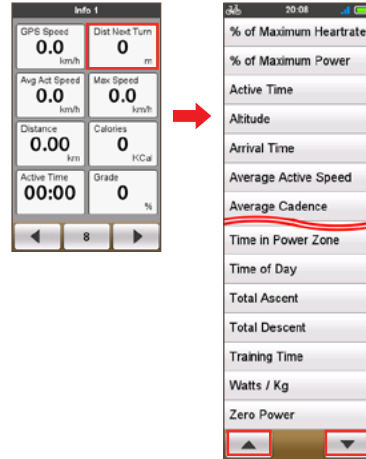
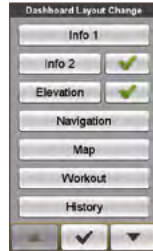

To change the screen layout:

1. Tap the corresponding button in the *Dashboard Layout Change* screen.
2. The number displayed at the bottom of the screen indicates the number of data fields (e.g. speed, distance, time, calories, etc.) included in the target screen.
3. Tap the numeric button and then select from the available number of data fields to display.
4. To select which information is displayed on the screen, tap on each individual data field (position) and then select a data item from the list to show in that position.

Sensors

Available sensors vary by model.

Sensor visibility is determined by type of selected profile - for example, a Running profile shows only the heart rate sensor, regardless of what other sensors may work with your device.

Sensor settings apply to the currently selected profile.

The main screen icons for each sensor or function are only displayed when the sensor or function is enabled in the currently selected profile.

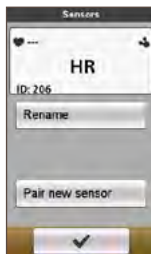

About sensors



The sensors “sleep” when not in use to conserve battery power. They “wake up” when they receive their usual input. For example, the Heart Rate Monitor’s pads must firmly touch your skin for the sensor to wake up.

The sensor can only be paired while they are awake. If a sensor stops receiving input, it goes back to sleep after a few minutes.

Pairing a sensor

When you pair a sensor, Cyclo stores the sensor ID and the name you assign it for connection purposes.

1. To pair a sensor, go to the **Settings > Sensors** screen, and make sure the desired sensor is enabled. (Green checkmark)
2. Tap the sensor button to see the Sensors page for that sensor. It will show the ID for the sensor of that type most recently paired.
3. Tap **Pair new sensor** to start pairing the sensor.

Once the connection is made, The sensor ID will be displayed in the **Connected Sensor ID** field. On the main screen, the appropriate icon / /  will display in the title bar.

For models with **Indoor** mode, you can pair your Cyclo with compatible trainers. The Trainer sensor is only available when an Indoor profile is active.

Note: The next time you start pairing to a sensor, it will attempt to pair to the last sensor paired. To connect to a different sensor, tap **Pair new sensor**.

Shimano Di2

Compatibility

For selected models only. Requires Shimano’s wireless transmitter. See Shimano’s resources for compatibility requirement and possible update procedures.

<http://e-tubeproject.shimano.com/index.html>

Settings

- **Cassette model:** Select the proper cassette model.
- **Cassette type:** Select the proper cassette type.
- **Crankset type:** Select the proper crankset type.
- **Battery status:**
 - When the Di2 sensor is connected, the current battery level is displayed.
 - When the battery level is 50%, the value flashes.
 - When the battery level is 30% or lower, the value appears in red.

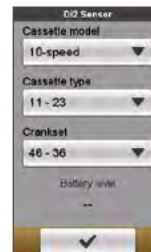

Phone

Tap the **Phone** option to turn on and off the Bluetooth function of the device.

For more information, see the “Pairing with your smartphone” section.

Note: For selected models only.

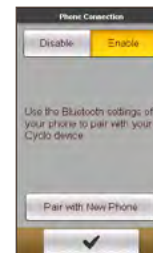

WiFi sync

Tap the **WiFi sync** option to turn on the WiFi function of the device.

For more information on using WiFi, see [page 23 Using WiFi \(wireless local area network\)](#).

Note: Enabling WiFi will consume power and reduce battery run time.

Note: For selected models only.

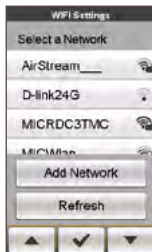



Where Am I

From the Main Menu, tap **Settings > Where Am I** to display the *The Where Am I* screen.

It displays your current GPS position with the coordinates info in map view. Tap  to see the number of satellites, your current position, and the strength of the signals.

For certain models, when the Cyclo device is paired with an Android phone, with a GPS fix, you can tap  to send the location message to your family or friend.

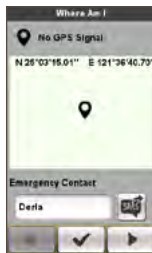

Note: This feature is not available on iPhone.

Tap  to input a number or further tap  to select a contact from your phonebook. To save a contact, tap .



Screen

- **Brightness:** Drag the slider to the left to decrease the screen brightness or to the right to increase the screen brightness.

Note: You can also decrease/increase the screen brightness by tapping  / .

Note: To increase your battery life during a ride, make sure the screen brightness is turned down to reduce the battery consumption.

- **Screen swipe:** Tap the option to enable or disable the slide controls on the screen.
- **Backlight Timer:** Tap the option to select how long (from **15 seconds** to **Never**) the display screen remains lit after you press the POWER button.
- **Screen Lock Timer:** Tap the option to select how long of inactivity (from **5 minutes** to **Never**) will lock the device screen.
- **Auto Power Off Timer:** Tap the option to select how long of inactivity (from **10 minutes** to **Never**) will turn off the device automatically.

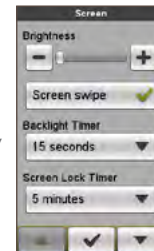

Transfer

Tap **Send/Receive** to exchange route with friends and tap **Disable/Enable** to turn on and off the Shake & Share function.

For more information of using File Sharing, see [page 23 Sharing your route with friends in the trip](#).



Maps

- **Auto Zoom:** Enable or disable automatic zooming during navigation.
If selected, the *Map* screen will automatically zoom in or out, depending on your speed, to allow optimal viewing of your route.
- **Show Cities:** Display or hide the current city name on the navigation/map screen.
- **Orientation:** Enable or disable displaying North at the top of the map screen.

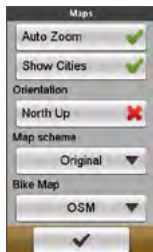

- **Map scheme:** Multiple color schemes are available. Select the preferred map display style.
- **Bike Map:** Select the preferred set of maps to load: **OSM** (Open Street Map) or **Tele Atlas**.

Notes:

1. The Car navigation mode is always performed using Tele Atlas maps.
2. When using Tele Atlas maps, most unpaved trails will not be visible.

Alerts

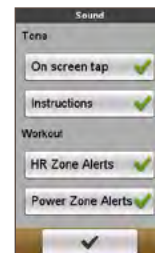

- **On screen tap:** Enable or disable the feedback sound while tapping on the screen.
- **Instructions:** Enable or disable the sound while getting instructions.
- **HR Zone Alerts:** Enable or disable the alert sound by HR Zone during your workout.
- **Power Zone Alerts:** Enable or disable the alert sound by Power Zone during your workout.



Manage

This setting allows you to manage the recorded data on the device, including: **History**, **Tracks**, **Favorites**, **Addresses**, and **POI**.

To manage the data:

1. Tap the corresponding button in the *Manage* screen.
2. Select the desired entry and then do one of the following:
 - Tap  to edit the name of the entry.
 - Tap  to delete the entry.

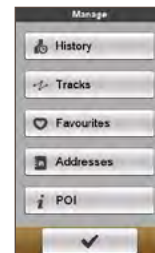

Define Zones

This setting option is for selected models only.

- **Heart Rate Zones:** Use Heart Rate Zones to target a specific heart rate and help you reach your training goals.
1. In the **Define Zones** field, select **By Age** (BPM or %) or **Custom** (BPM or %).
 - **By Age:** The **Maximum** heart rate value will be calculated (BPM or %) by the system based on the data in your profile.
 - **Custom:** You can input the **Maximum** heart rate value manually.

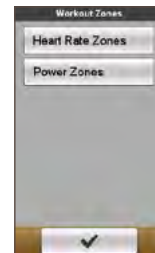

- Define the heart rate range in **Zone 1 ~ 6** fields according to your personal training purpose. Otherwise, you can just keep the default settings:

| Zone | Range (as % of Maximum) | Zone | Range (as % of Maximum) |
|------|----------------------------|------|----------------------------|
| 1 | 60 ~ 65 % | 4 | 83 ~ 89 % |
| 2 | 66 ~ 75 % | 5 | 90 ~ 94 % |
| 3 | 76 ~ 82 % | 6 | 95 ~ 100 % |

- When done, tap .

- Power Zones:** Setting the power zones will help you better understand how intense a workout might be.

- In the **Define Zones** field, select **FTP from History** or **Custom** (W or %).

- FTP from History:** The FTP (Functional Threshold Power) value will be calculated by the system based on the data in your training history.
- Custom:** You can input the **Maximum** power value manually.

- Define the heart rate range in Zone 1 ~ 6 fields according to your personal training purpose. Otherwise, you can just keep the default settings:

| Zone | Range (as % of FTP) | Zone | Range (as % of FTP) |
|------|------------------------|------|------------------------|
| 1 | < 55 % | 4 | 91 ~ 105 % |
| 2 | 56 ~ 75 % | 5 | 106 ~ 120 % |
| 3 | 76 ~ 90 % | 6 | > 121 % |

- When done, tap .

Note: Each zone has a different purpose and, generally speaking, the higher value of % means the harder of the workout.

Compass

The Compass calibration function allows you to calibrate the built-in compass of the device.

To calibrate the compass:

- Tap **Enable**.
- Move away from any sources of interference such as microwave oven and magnetic devices.
- Tap **Start calibration**.
- Move the device by waving your arm in a figure ∞ pattern (as shown on the screen) for several seconds.
- When done, the message “Compass calibration succeeded” will appear on the screen. An audible alert will also sound when complete. (If enabled.)

If you see the message “Compass calibration failed”, redo the movement again until calibration succeeds.

Note: While using the built-in electronic compass, place the device away from the objects that generate magnetic fields, such as electric appliances, magnets or high-voltage tower. This might cause your device point to the wrong direction.

Language

You can select the preferred language displayed for the menus and other interface features while operating the device.

- From the **Language** screen, tap on the language you want to use.

Keyboard

The device provides Russian, Bulgarian, and Greek keyboard for local users.

- From the **Keyboard** screen, tap the keyboard you want to use. Each enabled keyboard is displayed in addition to the standard numeric and ABC keyboards.

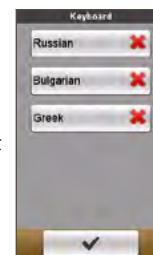
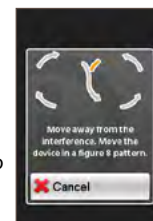
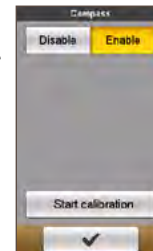

Date & Time

The device will display the date and time based on the current GPS location. The *Date & Time* screen lets you set the date/time format.

- **Set Date format:** Tap the button to select the displayed date format: **Day/Month/Year**, **Month/Day/Year**, or **Year/Month/Day**.
- **Set Time format:** You can set the displayed time format as 12-hour or 24-hour by tapping the **24h** or **AM/PM** button.

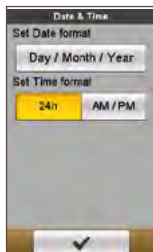

Units

The *Units* screen lets you select **Metric** or **Imperial** according with your preferences.

Selecting Imperial units will display distances as feet, yards, and miles, with weight in pounds, etc.



Product Info

The Product Info screen provides the general information of the device, including software and ROM versions, the End User License Agreement, and copyright information.

- You can reset the device to the factory default settings by tapping **Back to factory**. When you select the function, all of the recorded data on the device will be cleared.
- You can also just restore factory default settings by tapping **Restore Default**, allowing you to restore default settings but will not delete the recorded data.

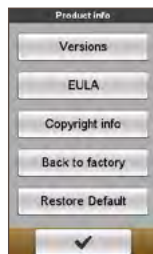

For more information

Online support

For 24/7 help and support with Magellan products, visit our Technical Support website at: www.MagellanGPS.com/support

Caring for your Cyclo

Taking good care of your Magellan will ensure trouble-free operation and reduce the risk of damage to your Cyclo :

- Keep your Cyclo away from excessive moisture and extreme temperatures.
- Avoid exposing your Cyclo to direct sunlight or strong ultraviolet light for extended periods of time.
- Do not place anything on top of your Cyclo or drop objects on your Cyclo .
- Do not drop your Cyclo or subject it to severe shock.
- Do not subject your Cyclo to sudden and severe temperature changes. This could cause moisture condensation inside the unit, which could damage your Cyclo . In the event of moisture condensation, allow your Cyclo to dry out completely before use.
- The screen surface can easily be scratched. Avoid touching it with sharp objects. Non-adhesive generic screen protectors designed specifically for use on portable devices with LCD panels may be used to help protect the screen from minor scratches.
- Never clean your Cyclo when it is turned on. Use a soft, lint-free cloth to wipe the screen and the exterior of your Cyclo .
- Do not use paper towels to clean the screen.
- Never attempt to disassemble, repair or make any modifications to your Cyclo . Disassembly, modification or any attempt at repair could cause damage to your Cyclo and even bodily injury or property damage and will void any warranty.
- Do not store or carry flammable liquids, gases or explosive materials in the same compartment as your Cyclo , its parts or accessories.
- Do not expose your Cyclo to extreme heat or direct sunlight for

prolonged periods. Overheating may damage your Cyclo .

About your heart rate monitor and accessories:

- Clean with a mild soap and water solution, dry with towel.
- Do not use alcohol or any abrasive material when cleaning the accessories.
- Rinse the strap under running water.
- Do not expose the accessories to extreme heat or direct sunlight for prolonged periods.
- Store the accessories in a cool and dry place.
- The estimated average battery lifespan of the accessories is 2 years. If your accessory stops working, replace with a new battery.
- Remove the battery from the accessories before long-term storage.

Troubleshooting

| Problems | Solutions |
|---|---|
| Your Cyclo does not turn on when using battery power. | The remaining battery power may be too low to run your Cyclo . Charge the battery. |
| Screen responds slowly. | Make sure that your Cyclo is not running out of battery power. If the problem still persists, restart your Cyclo . |
| Screen freezes. | Restart your Cyclo . |
| Screen is hard to read. | Make sure that the backlight of the display is set to a high-enough brightness. |
| Cannot establish a connection with a computer. | Make sure that your Cyclo and your computer are both turned on before trying to establish a connection. Make sure that the cable is securely plugged into the USB port on your computer and on your Cyclo . Connect the USB cable directly to your computer — do not run the cable through a USB hub. Restart your Cyclo before connecting the cable. Always disconnect your device before you restart your computer. |

Note: If you encounter a problem you cannot solve, contact an authorised service center for assistance.

What is GPS?

The Global Positioning System (GPS) is available at any time, free of charge, and is accurate to within 5m (15ft). GPS navigation is made possible by a network of satellites that orbit the Earth at around 20,200km (12,552mi). Each satellite transmits a range of signals which are used by GPS receivers, such as your Cyclo , to determine an exact location. Although a GPS receiver can detect signals from up to 12 satellites at any time, only four signals are required to provide a position or “GPS fix” (latitude and longitude), for vehicle navigation systems.

Your Cyclo receives GPS signals via the internal GPS antenna. To guarantee the optimum GPS signal strength, ensure your Cyclo is outdoors, or in a vehicle outdoors, and has an unobstructed view of the sky. GPS reception is not usually affected by weather, however, very heavy rain or snow may have a negative effect on your reception.

CAUTION:

- It is your sole responsibility to place, secure and use your Cyclo in a manner that will not cause accidents, personal injury or property damage. Always observe safe driving practices.
- On main roads, the distance to an exit calculated by your Cyclo may be further than the distance shown on road signs. Road signs show the distance to the start of an exit while your Cyclo shows the distance to the next intersection, i.e., the end of the exit ramp or road. To prepare to exit a road, always follow distance information on road signs.
- Magellan products are designed to be used as an aid to safer driving. Magellan does not condone speeding or any other failure to comply with your local traffic laws. It is your responsibility to drive within the posted speed limit at all times and to drive in a careful manner. Magellan accepts NO liability whatsoever for you receiving any speeding fines or points on your license through using this device. Magellan does not guarantee the accuracy of the data contained within this database either expressed or implied. In the event you receive a fine or any other penalty for speeding or contravention of any traffic law, or are involved in an accident, Magellan is not responsible for any damages of any type. In some countries the data information regarding speed limits may conflict with local law and/or regulations. It is your responsibility to make sure that your use of the data is in compliance with local laws and/or regulations. Usage is at your own risk.
- Do not operate the device while driving or riding a bike. Using this product does not change the requirement for a driver or a bike rider to take full responsibility for his or her behaviour. This responsibility includes observing all traffic rules and regulations in order to avoid accidents, personal injury or property damage.

IPX7

The IEC 60529/IPX7 is a European system of test specification standards for classifying the degrees of protection provided by the enclosures of electrical equipment. An IPX7 designation means that the unit withstands immersion in one meter (approx 3ft) of still water for up to 30 minutes. Magellan guarantees this grade provided the battery door and all jack covers are properly and securely closed. Magellan Cyclo is not IPX8 grade; water-pressure such as washing the unit with running water may cause damage to the unit and voids warranty.

Safety precautions

• About charging

- Use only the charger supplied with your device. Use of another type of charger will result in malfunction and/or danger.
- This product is intended to be supplied by a LISTED Power Unit marked with "LPS", "Limited Power Source" and output rated + 5 V dc / 1.0 A".
- Use a specified battery in the equipment.

• About the charger

- Do not use the charger in a high moisture environment. Never touch the charger when your hands or feet are wet.
- Allow adequate ventilation around the charger when using it to operate the device or charge the battery. Do not cover the charger with paper or other objects that will reduce cooling. Do not use the charger while it is inside a carrying case.
- Connect the charger to a proper power source. The voltage requirements are found on the product case and/or packaging.
- Do not use the charger if the cord becomes damaged.
- Do not attempt to service the unit. There are no serviceable parts inside. Replace the unit if it is damaged or exposed to excess moisture.

• About the battery

CAUTION: This unit contains a non-replaceable internal Lithium Ion battery. The battery can burst or explode, releasing hazardous chemicals. To reduce the risk of fire or burns, do not disassemble, crush, puncture, or dispose of in fire or water.

Regulatory information

For regulatory identification purposes, Magellan Cyclo 310/315/500/505 is assigned a model number of N429.

Marking labels located on the exterior of your device indicate the regulations that your model complies with. Please check the marking labels on your device and refer to the corresponding statements in this section. Some notices apply to specific models only.



Products with the CE marking comply with Radio & Telecommunication Terminal Equipment Directive (R&TTE) (1999/5/EC), the Electromagnetic Compatibility Directive (2004/108/EC) and the Low Voltage Directive (2006/95/EC) - issued by the Commission of the European Community. Compliance with these directives implies conformity to the following European Standards: EN301489-3, EN301357

EN 300 440-1/-2(ANT+): Electromagnetic compatibility and Radio spectrum Matters (ERM); Short range devices; Radio equipment to be used in the 1 GHz to 40 GHz frequency range; Part 1: Technical characteristics and test methods/ Part 2: Harmonized EN covering the essential requirements of article 3.2 of the R&TTE Directive.

EN 301 489-1: Electronic compatibility and Radio spectrum Matters (ERM), Electromagnetic Compatibility (EMC) standard for radio equipment and services; Part 1: Common technical requirements.

EN 301 489-3(ANT+): Electromagnetic compatibility and Radio spectrum Matters (ERM); ElectroMagnetic Compatibility (EMC) standard for radio equipment and services; Part 3: Specific conditions for Short-Range Devices (SRD) operating on frequencies between 9 kHz and 40 GHz.

EN 301 489-17: Electronic compatibility and Radio spectrum Matters (ERM), Electromagnetic Compatibility (EMC) standard for radio equipment and services; Part 17: Specific conditions for 2.4 GHz wideband transmission systems and 5 GHz high performance RLAN equipment.

EN 300 328: (Bluetooth) Electromagnetic compatibility and Radio spectrum Matters (ERM); Wideband Transmission systems; Data transmission equipment operating in the 2.4 GHz ISM band and using spread spectrum modulation techniques; Harmonized EN covering

essential requirements under article 3.2 of the R&TTE Directive.

EN 55022: Radio disturbance characteristics

EN 55024: Immunity characteristics

EN 61000-3-2: Limits for harmonic current emissions

EN 61000-3-3: Limitation of voltage fluctuation and flicker in low-voltage supply system

EN 62209-2(SAR): Human exposure to radio frequency fields from hand-held and body mounted wireless communication devices. Human models, instrumentation, and procedures. Procedure to determine the specific absorption rate (SAR) for wireless communication devices used in close proximity to the human body (frequency range of 30 MHz to 6 GHz).

IEC 60950-1:2005: Product Safety

The manufacturer cannot be held responsible for modifications made by the User and the consequences thereof, which may alter the conformity of the product with the CE Marking.

Declaration of Conformity

Hereby, MiTAC declares that this N429 is in compliance with the essential requirements and other relevant provisions of Directive 1999/5/EC.

Bluetooth



Bluetooth QD ID
B021873

WEEE



This product must not be disposed of as normal household waste, in accordance with the EU directive for waste electrical and electronic equipment (WEEE - 2002/96/EC). Instead, it should be disposed of by returning it to the point of sale, or to a municipal recycling collection point.

End User License Agreement

You should read the following terms and conditions of this Agreement ("Agreement") carefully before using this Magellan Cyclo device, its accessories and any other accompanying items ("Product") that includes licensed products, including but not limited to software, digital map data or other data and services ("Software") licensed by MITAC Europe Limited, company number 4214164, registered address in Spectrum House, Beehive Ring Road, London Gatwick Airport, RH6 0LG, United Kingdom and MITAC Benelux NV, company number 0450804332, registered address in Zone 5 Mollem 318, 1730 Mollem, Asse, Belgium, URL: eu.mitac.com ("Mio") to be used only, as set forth below. For any further information on Product or support, consult URL: www.magellangps.com/support.

IF YOU DO NOT AGREE TO THE TERMS OF THIS END USER LICENSE AGREEMENT, PLEASE DO NOT USE THIS PRODUCT AND DO NOT COPY ANY SOFTWARE INSTALLED THEREIN. IN SUCH CASE, PROMPTLY CONTACT MAGELLAN OR ANY AUTHORIZED DEALER FOR INSTRUCTIONS TO RETURN THE UNUSED PRODUCT WITH ALL ACCOMPANYING ITEMS. SHOULD YOU HAVE PAID FOR THE PRODUCT OR THE SOFTWARE, MAGELLAN OR ANY AUTHORIZED DEALER MAY REFUND THE PURCHASE PRICE PROVIDED THAT YOU PROVIDE A VALID AND ACCEPTED PROOF OF PURCHASE AND PROOF OF PAYMENT. ANY USE OF THE PRODUCT OR SOFTWARE WILL CONSTITUTE YOUR ACCEPTANCE OF THIS AGREEMENT.

GRANT OF LICENSE: This Agreement grants you a non-exclusive and revocable license to use the Software installed on the hardware device or any other storage medias (on only one hardware device at a time), for your internal business purposes or personal use.

This Agreement does not imply or grant you any rights to future updates or upgrades of the Software unless expressly instructed by Magellan in writing. Any updates or upgrades are governed by this Agreement and may be subject to additional payments and other conditions.

You may copy Software or any supporting and accompanying documentation ("Documentation") for backup or archive purposes only and for the support of use of the Software as permitted hereunder. All such copies must reproduce and include all copyright notices and any other proprietary rights notice appearing on the Software and Documentation.

The Documentation may contain mulNotele versions of this Agreement, including but not limited to mulNotele translations and mulNotele media versions. Even if you receive mulNotele versions of this Agreement, you are licensed to use only one copy of the Software.

THE SOFTWARE LICENSED HEREUNDER MAY CONTAIN DEFECTS. YOU ARE ADVISED NOT TO RELY ON THIS SOFTWARE, TO SAFEGUARD IMPORTANT DATA, TO USE CAUTION AND NOT TO RELY IN ANY WAY ON THE CORRECT FUNCTIONING OR PERFORMANCE OF THE SOFTWARE AND ACCOMPANYING MATERIALS.

The software is not designed or licensed for use in mission-critical applications, or in hazardous environments, requiring fail-safe controls, including without limitation operation of nuclear facilities, aircraft navigation or communication systems, air traffic control, or life support or weapons systems.

To the maximum extent permitted by applicable law, the Software is provided to you "AS IS AND WITH ALL FAULTS", and Magellan, its suppliers and licensors hereby disclaim any warranty, express or implied (either in fact or by operation of law), with respect to the Software, either as to merchantability, fitness for particular purpose, or any other matter. You acknowledge and agree that the Software has not been tested or certified by any government agency or industry regulatory organization or any other third party organization. In no event shall Magellan, its suppliers and licensors be held liable for, liabilities or obligations for damages, including but not limited to special, indirect, or consequential damages or loss of use, revenue, or profits in connection with or arising out of this Agreement or any breach of this Agreement by Magellan, its suppliers or licensors or the existence, furnishing, functioning, or any use of the Software. Any other representations or warranties made by any person, including employees

or representatives of Magellan , its suppliers and licensors, which are inconsistent herewith shall be disregarded by you and shall not be binding upon Magellan , its suppliers and licensors, if any product model or sample was shown to you, such model or sample was used merely to illustrate the general type and quality of the product and not to represent that the Software would necessarily conform with such model or sample. NO ORAL OR WRITTEN ADVICE OR INFORMATION PROVIDED BY MAGELLAN , ITS SUPPLIERS AND LICENSORS OR ON THEIR BEHALF SHALL CREATE A WARRANTY OR IN ANY WAY INCREASE THE SCOPE OF THIS LIMITED WARRANTY, AND YOU ARE NOT ENTITLED TO RELY ON ANY SUCH ADVICE OR INFORMATION.

Any liability of Magellan , its suppliers and licensors towards you shall be void if any damage to the Product is caused by accident, transportation, neglect or misuse, alteration (which shall include, but not be limited to, any deviation from the specifications), any unauthorized modification or enhancement of the Product, failure to maintain a suitable operating environment, or the use of the Product for other than the specific purpose for which it was designed.

In no event shall Magellan , its suppliers and licensors be liable for any third party materials, database and/or their content including the GUI and all other implications arising from such error or malfunction related to database.

Provision of the Product under this Agreement shall not create any obligation for Magellan , its suppliers and licensors to continue to develop, productize, support, repair, offer for sale or in any other way continue to provide or develop software either to you or to any other party.

RESTRICTIONS: You are not permitted to: analyze, modify, translate, adapt, reverse engineer, decompile, disassemble, or otherwise reduce the Software to a perceivable form; create derivative works based on the Software or any part thereof, or attempt to increase the functionality of the Software in any manner; copy or download the Software (except for backup purposes as stated above), reproduce through any electronic or mechanical means, and distribute copies – any unauthorized copying is expressly prohibited; rent, lend, resell, distribute, sublicense or otherwise transfer rights to the Software, in any other way than assigning the Product in meeting with below conditions; remove or obscure any copyright or proprietary notices or labels in the Software; perform, broadcast, display or present the Software in public.

The Software is the confidential information of Magellan , its suppliers and licensors. You are not allowed to disclose the Software to third parties.

The removal or obscuring of any copyright, trademark notice or restrictive legend of Magellan , its suppliers and licensors is not allowed.

ASSIGNMENT: Provided the transferee agrees to the terms of this Agreement, transfer of the Product may be allowed. Such transfer must include all copies of the Software and Documentation without restriction. It also includes all prior versions, updates and upgrades of the Software.

EXPORT RESTRICTIONS: You accept to comply with all applicable international or national laws (of the European Union, the United States of America or other) that apply to the Product, including the Software and the Documentation, and shall not export or re-export the Product, the Software and the Documentation (or any copies thereof) or any product utilizing the Product, the Software or the Documentation in violation of any applicable laws or regulations to any person or entity in any country subject to such restrictions, including but not limited to Cuba, Iran, Libya, North Korea, Sudan and Syria, or to any person or entity, wherever located, who intends to export or re-export to such country. For further information in relation to this restriction, please seek advice from the relevant governmental agencies.

INTELLECTUAL PROPERTY RIGHTS: Magellan or its suppliers or licensors, own all intellectual property rights in and to the Product, the Software and the Documentation, and any copies thereof. Except as expressly provided herein, this Agreement does not grant you any rights to patent, copyrights, trade secret, trademarks, or any other intellectual property rights.

TERMINATION: This Agreement is effective as of the date of its acceptance until expired or terminated according to the terms of this Agreement. You may terminate this Agreement at any time by destroying the Product, the Software and the Documentation together with all copies and merged portions in any form. This Agreement may be terminated immediately by Magellan for any reason, including but not limited to any failure to comply with any term or condition of this Agreement. In such event, you must destroy the Product, the Software and the Documentation together with all copies and merged portions in any form. In addition, this Agreement shall terminate immediately upon the termination of the agreement between Magellan and any third-party from whom Magellan licenses Software. All rights granted to you by this Agreement shall cease upon termination

including, but not limited to, all licenses granted hereunder.

GOVERNING LAW: This Agreement shall be governed by the laws of England.

LIMITED WARRANTY; LIMITED LIABILITY: All warranties and limitations of liability applicable to the Product, the Software and the Documentation are as stated on the limited warranty provisions as provided by the limited warranty statement to this Product or in the manual regarding the Product or Software ("Limited Warranty"). Such warranties and limitations of liability are entirely incorporated herein by this reference.

EXCEPT AS PROHIBITED BY LAW, MAGELLAN AND ITS SUPPLIERS OR LICENSORS SHALL HAVE NO LIABILITY FOR ANY INDIRECT, SPECIAL, CONSEQUENTIAL, PUNITIVE OR INCIDENTAL DAMAGES OF ANY KIND, OR LOSS OF INFORMATION OR DATA, ARISING FROM OR IN CONNECTION WITH THE USE OR PERFORMANCE OF THE PRODUCT, SOFTWARE AND DOCUMENTATION. THIS LIMITATION SHALL APPLY EVEN IF ANY REMEDY FAILS OF ITS ESSENTIAL PURPOSE.

SEVERABILITY: In the event any provision of this Agreement is found to be invalid, illegal or unenforceable, the remaining provisions shall be still valid, legal and enforceable without being affected or impaired in any way and a valid, legal and enforceable provision of similar intent and economic impact shall be substituted therefore.

ENTIRE AGREEMENT: This Agreement sets forth the entire understanding and agreement between you and Magellan with respect to the Product, the Software and the Documentation, and supersedes all prior agreements and communications, whether orally or written thereof.